

EMSHIELD WFR2 SYSTEM

INSTALL DATA

DO NOT OPEN ANY PACKAGES or install this material until all members of your crew have read and understand these instructions as well as all relevant MSDS sheets. If you do not understand any part of these instructions CALL EMSEAL: 800-526-8365 or 508-836-0280

This document does not purport to address all of the safety concerns, if any, associated with this product's use. It is the responsibility of the user of this document to establish appropriate safety and health practices and to determine the applicability of regulatory limitations prior to use. The use of a dust mask, safety goggles and gloves is recommended. Keep out of reach of children.

IMPORTANT: This product cannot perform its intended function if not properly installed.

1 Equipment & Material Storage

In addition to safety equipment required to comply with applicable Federal, state and local safety regulations, equipment to prepare and repair the joint-faces, as well as normal tools of the trade, the following are required:

Equipment Checklist:

- Tape measure
- Mixing paddle and heavy-duty, low-speed drill for mixing epoxy adhesive
- Small caulking gun for 10-oz silicone tubes provided
- Large 27-oz caulking gun for intumescent caulk tubes provided
- Long-bladed, serrated bread knife
- Hacksaw
- Miter box or miter block
- Spray bottle with water
- Masking Tape (2 1/2 times the length of joint)
- Spatula to scrape epoxy from can
- Chemical-resistant gloves
- 2-inch wide (50mm) margin trowels for applying epoxy adhesive on the substrate.
- 1/2" and 1" caulk knives for tooling sealant bands
- Toluene* for cleaning joint-faces, trowels and mixer tools
- Clean lint-free, 100% cotton rags

Cold Days: Store Sealant, off the floor, inside at above 68° F (20° F). It will recover slower when cold and faster when warm.

Very Hot Days: Keep sealant out of direct sun when the temperature is greater than 60° F (15° C) until immediately prior to installation into joint.

*Solvents mentioned or referred to are toxic and flammable. Observe solvent manufacturer's precautions and refer to Material Safety Data Sheets as well as local and federal requirements for same handling and use.

2 Prepare & Solvent-Wipe Joint Faces

Concrete:

- Remove loose particles and weak or unsound concrete or other substrate material to ensure a solid, sound substrate. Spalls, chipped edges and uneven surfaces must be repaired using proper material and methods to ensure maintenance of the fire-rated wall-assembly construction. Joint faces must be parallel.
- Joints must have unobstructed depth greater than or equal to the full depth of the largest material supplied plus 1/2-inch (6mm).
- Dry all wet surfaces.
- Wipe joint faces with dampened, lint-free rags to remove all concrete dust and contaminants.

Metal:

- Solvent-wipe immediately prior to applying WFR2 epoxy.

IMPORTANT: Ensure that there is no oxidation (rust) on metal substrates before the epoxy is applied.

Other Substrates: Contact EMSEAL.

3 Measure Joint Width & Find Correct Size Material

- Measure joint width at wall surface and inside of the gap to ensure joint faces are parallel.
- Material has been supplied to suit your mean temperature field-measured joint widths. Widths of material supplied are marked on each stick of material. Find correct box and open it.
- Compare width of material supplied as marked on each stick against mean joint width. Actual width of material as measured between hardboard will be slightly less than marked size because material is over-compressed for ease of installation.

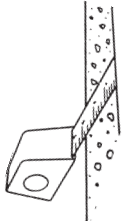

NOTE: If unsure of correct material selection, consult EMSEAL.

IMPORTANT: Do not remove outer plastic packaging until you have read and understand the rest of these instructions as material may expand before you can get it into the joint.

4 Mask Walls & Mix Epoxy Adhesive

- Tape off the walls on both sides of the joint.

Mix Epoxy

- EMSEAL epoxy adhesive may be used in the 41° F (5° C) to 95° F (35° C) temperature range.
- Using a trowel, transfer the entire contents of Part B (hardener) into the contents of Part A (base).
- Mix the material thoroughly with a drill and mixing paddle. Scrape the walls and bottom of the container to ensure uniform and complete mixing.
- Always mix component B (hardener) into component A (base). Ensure that a uniform gray color with no black or white streaks is obtained.

IMPORTANT: DO NOT thin the epoxy.

- **Precaution:** Wear chemical-resistant gloves and/or barrier hand cream when handling liquid sealant or epoxy. Remove promptly from skin with a commercial hand cleaner before eating or smoking. Avoid inhaling vapors.

5 Apply Epoxy to Substrate, Unwrap WFR2

Ensure that the mixed epoxy adhesive is applied to the substrate before the pot life has expired (10 - 30 minutes depending on the ambient temperature).

WARNING: Epoxy will harden more quickly when left in the pot. Apply it onto the joint face as soon as possible.

IMPORTANT: The epoxy must still be uncured when installing WFR2 foam into the joint-gap.

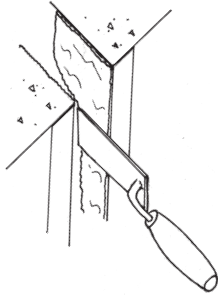

If the epoxy cures before installing the WFR2 foam then reapply new epoxy. If work is interrupted for more than 2 hours after initial cure then grind the old epoxy, solvent wipe, and apply new wet epoxy.

IMPORTANT: While one or more workers are applying epoxy to the joint faces, others must prepare the WFR2 foam. The WFR2 foam is kept under compression by plastic wrapping and hardboard on both sides.

- Slit the plastic packing by cutting on the hardboard and remove hardboard and inner release liner. DO NOT cut along the silicone bellows.

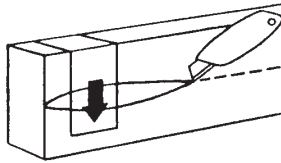

IMPORTANT: Work quickly and deliberately after cutting the shrink-wrap to avoid material expanding beyond a usable size.

6 Wipe Release Agent off Silicone Facing

- For packaging and production reasons, the silicone facing is coated in the factory with a release agent.
- Prior to installation, this agent must be wiped off in order for the injected sealant bands described in Step #9 to adhere to the silicone facing and to avoid contamination of the substrate at this point.
- To remove the release agent, lightly, quickly and thoroughly wipe the cured silicone facing with a lint-free rag made damp with water.



7 Apply Silicone & Intumescent Caulk to Bellows Face & Install First WFR2 Foam Length into Joint

- On the end of the first stick, using a caulk gun and the tubes of silicone provided, apply the liquid silicone to the exposed faces of the silicone bellows.
- Using a large caulk gun and the tube of intumescent sealant provided, apply the intumescent sealant to the exposed face of the intumescent bellows and to the exposed face of the foam.
- Use a caulk knife spread the intumescent sealant over the face of the foam to an even 1/16th-inch (2mm) thickness.
- Starting at the bottom of the joint, install the WFR2 foam into the joint. Ensure that the epoxy on the joint face has not cured.
- Note: When material is correctly expanded for a snug fit it will support its own weight in the joint.
- Feed material into joint, starting from one end. The material should fit snugly and must be eased into the joint with steady, firm pressure.
- When installed, the WFR2 must be recessed so that the top of the outward-facing bellows is flush or slightly set back from the wall surface.
- Repeat step #6 for each new stick.

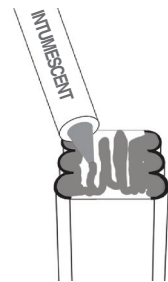
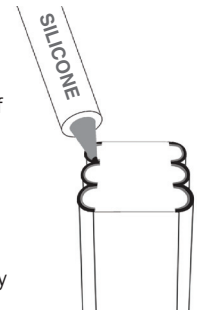

IMPORTANT: All sticks of WFR2 foam MUST have a coating of intumescent on the faces of all joints. This ensures that joints do not compromise the fire barrier.

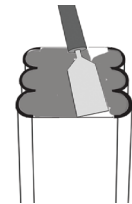

8 Install Next Length. Repeat.

- Work in one direction towards the previously installed length or end of joint. Do not stretch material.
- Coat the top end of the next step with silicone and intumescent caulk as described in Step 8 above.
- Insert the uncoated bottom end of the stick into the joint and line it up with the previously installed stick.
- **Push Hard** on the stick to compress the joint firmly together. Ensure there are no voids at joints.
- During low temperature installation, provide as much ambient heat as possible around installed WFR2 foam to accelerate recovery.
- Using a caulk knife, tool any silicone that squeezes out of the joint and blend it into the precured silicone bellows. Be sure not to fill in the valleys of the bellows as this will constrain movement.

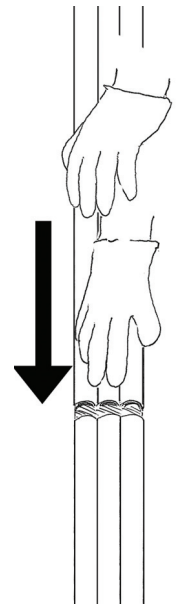

9 Inject Silicone Sealant Bands at Substrates & Tool Excess Silicone

- Wipe any excess epoxy from the face of material using a clean rag.
- Before the epoxy cures, force the tip of the silicone caulk tube between the substrate and the WFR2 foam. Inject a 3/4-inch (20mm) deep silicone sealant band between the foam, cured silicone facing and the joint-face.
- Tool the freshly applied silicone firmly to blend with the substrates and cured silicone facing, and to ensure a proper bond and seamless appearance.

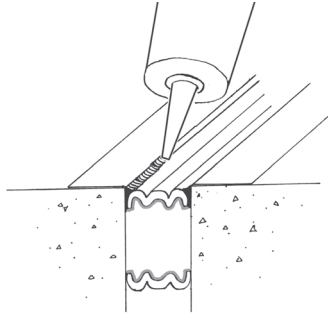

- Where WFR2 foam meets at butt joints, tool the excess silicone that squeezes out from the top and between the bellows. **IMPORTANT: Silicone left between the wrinkles of the bellows could constrain movement -- using a caulk knife, remove excess sealant and blend what remains into the bellows.**
- **Note:** Silicone sealant band is only applied to the weather side of the WFR2 foam. No sealant band is needed on the other side.

SILICONE-COAT ANY EXPOSED FOAM ENDS:

IMPORTANT: Any stick of WFR2 which finishes with an open end, not terminating into another stick or structural termination, must be lightly coated on the exposed foam end using the liquid silicone sealant provided. This is critical to ensure that the fire-retardant impregnated foam is sealed.

NOTES